



Geotechnical Engineering  
Construction Observation/Testing  
Environmental Services



**GEOTECHNICAL ENGINEERING STUDY  
LORENZINI SHORT PLAT  
4719 – 86<sup>TH</sup> AVENUE SOUTHEAST AND  
84XX SOUTHEAST 47<sup>TH</sup> STREET  
MERCER ISLAND, WASHINGTON**

**ES-8009.01**

15365 N.E. 90th Street, Suite 100 Redmond, WA 98052  
(425) 449-4704 Fax (425) 449-4711  
[www.earthsolutionsnw.com](http://www.earthsolutionsnw.com)

**PREPARED FOR**  
**DESIGN BUILT HOMES, LLC**

**February 1, 2022**

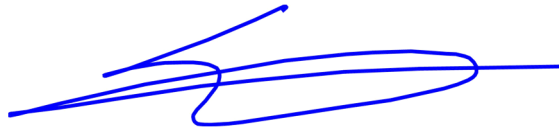

---

**Stephen H. Avril**  
**Project Manager**



---

**Kyle R. Campbell, P.E.**  
**Principal Engineer**

**GEOTECHNICAL ENGINEERING STUDY**  
**LORENZINI SHORT PLAT**  
**4719 – 86<sup>TH</sup> AVENUE SOUTHEAST AND**  
**84XX SOUTHEAST 47<sup>TH</sup> STREET**  
**MERCER ISLAND, WASHINGTON**

**ES-8009.01**

**Earth Solutions NW, LLC**  
**15365 Northeast 90<sup>th</sup> Street, Suite 100**  
**Redmond, Washington 98052**  
**Phone: 425-449-4704 | Fax: 425-449-4711**  
**[www.earthsolutionsnw.com](http://www.earthsolutionsnw.com)**

# Important Information about This

# Geotechnical-Engineering Report

Subsurface problems are a principal cause of construction delays, cost overruns, claims, and disputes.

While you cannot eliminate all such risks, you can manage them. The following information is provided to help.

**The Geoprofessional Business Association (GBA) has prepared this advisory to help you – assumedly a client representative – interpret and apply this geotechnical-engineering report as effectively as possible. In that way, you can benefit from a lowered exposure to problems associated with subsurface conditions at project sites and development of them that, for decades, have been a principal cause of construction delays, cost overruns, claims, and disputes. If you have questions or want more information about any of the issues discussed herein, contact your GBA-member geotechnical engineer. Active engagement in GBA exposes geotechnical engineers to a wide array of risk-confrontation techniques that can be of genuine benefit for everyone involved with a construction project.**

## Understand the Geotechnical-Engineering Services Provided for this Report

Geotechnical-engineering services typically include the planning, collection, interpretation, and analysis of exploratory data from widely spaced borings and/or test pits. Field data are combined with results from laboratory tests of soil and rock samples obtained from field exploration (if applicable), observations made during site reconnaissance, and historical information to form one or more models of the expected subsurface conditions beneath the site. Local geology and alterations of the site surface and subsurface by previous and proposed construction are also important considerations. Geotechnical engineers apply their engineering training, experience, and judgment to adapt the requirements of the prospective project to the subsurface model(s). Estimates are made of the subsurface conditions that will likely be exposed during construction as well as the expected performance of foundations and other structures being planned and/or affected by construction activities.

The culmination of these geotechnical-engineering services is typically a geotechnical-engineering report providing the data obtained, a discussion of the subsurface model(s), the engineering and geologic engineering assessments and analyses made, and the recommendations developed to satisfy the given requirements of the project. These reports may be titled investigations, explorations, studies, assessments, or evaluations. Regardless of the title used, the geotechnical-engineering report is an engineering interpretation of the subsurface conditions within the context of the project and does not represent a close examination, systematic inquiry, or thorough investigation of all site and subsurface conditions.

## Geotechnical-Engineering Services are Performed for Specific Purposes, Persons, and Projects, and At Specific Times

Geotechnical engineers structure their services to meet the specific needs, goals, and risk management preferences of their clients. A geotechnical-engineering study conducted for a given civil engineer

will not likely meet the needs of a civil-works constructor or even a different civil engineer. Because each geotechnical-engineering study is unique, each geotechnical-engineering report is unique, prepared *solely* for the client.

Likewise, geotechnical-engineering services are performed for a specific project and purpose. For example, it is unlikely that a geotechnical-engineering study for a refrigerated warehouse will be the same as one prepared for a parking garage; and a few borings drilled during a preliminary study to evaluate site feasibility will not be adequate to develop geotechnical design recommendations for the project.

Do not rely on this report if your geotechnical engineer prepared it:

- for a different client;
- for a different project or purpose;
- for a different site (that may or may not include all or a portion of the original site); or
- before important events occurred at the site or adjacent to it; e.g., man-made events like construction or environmental remediation, or natural events like floods, droughts, earthquakes, or groundwater fluctuations.

Note, too, the reliability of a geotechnical-engineering report can be affected by the passage of time, because of factors like changed subsurface conditions; new or modified codes, standards, or regulations; or new techniques or tools. *If you are the least bit uncertain* about the continued reliability of this report, contact your geotechnical engineer before applying the recommendations in it. A minor amount of additional testing or analysis after the passage of time – if any is required at all – could prevent major problems.

## Read this Report in Full

Costly problems have occurred because those relying on a geotechnical-engineering report did not read the report in its entirety. Do not rely on an executive summary. Do not read selective elements only. *Read and refer to the report in full.*

## You Need to Inform Your Geotechnical Engineer About Change

Your geotechnical engineer considered unique, project-specific factors when developing the scope of study behind this report and developing the confirmation-dependent recommendations the report conveys. Typical changes that could erode the reliability of this report include those that affect:

- the site's size or shape;
- the elevation, configuration, location, orientation, function or weight of the proposed structure and the desired performance criteria;
- the composition of the design team; or
- project ownership.

As a general rule, *always* inform your geotechnical engineer of project or site changes – even minor ones – and request an assessment of their impact. *The geotechnical engineer who prepared this report cannot accept*

responsibility or liability for problems that arise because the geotechnical engineer was not informed about developments the engineer otherwise would have considered.

### Most of the “Findings” Related in This Report Are Professional Opinions

Before construction begins, geotechnical engineers explore a site’s subsurface using various sampling and testing procedures. *Geotechnical engineers can observe actual subsurface conditions only at those specific locations where sampling and testing is performed.* The data derived from that sampling and testing were reviewed by your geotechnical engineer, who then applied professional judgement to form opinions about subsurface conditions throughout the site. Actual sitewide-subsurface conditions may differ – maybe significantly – from those indicated in this report. Confront that risk by retaining your geotechnical engineer to serve on the design team through project completion to obtain informed guidance quickly, whenever needed.

### This Report’s Recommendations Are Confirmation-Dependent

The recommendations included in this report – including any options or alternatives – are confirmation-dependent. In other words, they are not final, because the geotechnical engineer who developed them relied heavily on judgement and opinion to do so. Your geotechnical engineer can finalize the recommendations *only after observing actual subsurface conditions* exposed during construction. If through observation your geotechnical engineer confirms that the conditions assumed to exist actually do exist, the recommendations can be relied upon, assuming no other changes have occurred. *The geotechnical engineer who prepared this report cannot assume responsibility or liability for confirmation-dependent recommendations if you fail to retain that engineer to perform construction observation.*

### This Report Could Be Misinterpreted

Other design professionals’ misinterpretation of geotechnical-engineering reports has resulted in costly problems. Confront that risk by having your geotechnical engineer serve as a continuing member of the design team, to:

- confer with other design-team members;
- help develop specifications;
- review pertinent elements of other design professionals’ plans and specifications; and
- be available whenever geotechnical-engineering guidance is needed.

You should also confront the risk of constructors misinterpreting this report. Do so by retaining your geotechnical engineer to participate in prebid and preconstruction conferences and to perform construction-phase observations.

### Give Constructors a Complete Report and Guidance

Some owners and design professionals mistakenly believe they can shift unanticipated-subsurface-conditions liability to constructors by limiting the information they provide for bid preparation. To help prevent the costly, contentious problems this practice has caused, include the complete geotechnical-engineering report, along with any attachments or appendices, with your contract documents, *but be certain to note*

*conspicuously that you’ve included the material for information purposes only.* To avoid misunderstanding, you may also want to note that “informational purposes” means constructors have no right to rely on the interpretations, opinions, conclusions, or recommendations in the report. Be certain that constructors know they may learn about specific project requirements, including options selected from the report, *only* from the design drawings and specifications. Remind constructors that they may perform their own studies if they want to, and *be sure to allow enough time* to permit them to do so. Only then might you be in a position to give constructors the information available to you, while requiring them to at least share some of the financial responsibilities stemming from unanticipated conditions. Conducting prebid and preconstruction conferences can also be valuable in this respect.

### Read Responsibility Provisions Closely

Some client representatives, design professionals, and constructors do not realize that geotechnical engineering is far less exact than other engineering disciplines. This happens in part because soil and rock on project sites are typically heterogeneous and not manufactured materials with well-defined engineering properties like steel and concrete. That lack of understanding has nurtured unrealistic expectations that have resulted in disappointments, delays, cost overruns, claims, and disputes. To confront that risk, geotechnical engineers commonly include explanatory provisions in their reports. Sometimes labeled “limitations,” many of these provisions indicate where geotechnical engineers’ responsibilities begin and end, to help others recognize their own responsibilities and risks. *Read these provisions closely.* Ask questions. Your geotechnical engineer should respond fully and frankly.

### Geoenvironmental Concerns Are Not Covered

The personnel, equipment, and techniques used to perform an environmental study – e.g., a “phase-one” or “phase-two” environmental site assessment – differ significantly from those used to perform a geotechnical-engineering study. For that reason, a geotechnical-engineering report does not usually provide environmental findings, conclusions, or recommendations; e.g., about the likelihood of encountering underground storage tanks or regulated contaminants. *Unanticipated subsurface environmental problems have led to project failures.* If you have not obtained your own environmental information about the project site, ask your geotechnical consultant for a recommendation on how to find environmental risk-management guidance.

### Obtain Professional Assistance to Deal with Moisture Infiltration and Mold

While your geotechnical engineer may have addressed groundwater, water infiltration, or similar issues in this report, the engineer’s services were not designed, conducted, or intended to prevent migration of moisture – including water vapor – from the soil through building slabs and walls and into the building interior, where it can cause mold growth and material-performance deficiencies. Accordingly, *proper implementation of the geotechnical engineer’s recommendations will not of itself be sufficient to prevent moisture infiltration.* **Confront the risk of moisture infiltration** by including building-envelope or mold specialists on the design team. **Geotechnical engineers are not building-envelope or mold specialists.**



Telephone: 301/565-2733  
e-mail: [info@geoprofessional.org](mailto:info@geoprofessional.org) [www.geoprofessional.org](http://www.geoprofessional.org)

Copyright 2019 by Geoprofessional Business Association (GBA). Duplication, reproduction, or copying of this document, in whole or in part, by any means whatsoever, is strictly prohibited, except with GBA’s specific written permission. Excerpting, quoting, or otherwise extracting wording from this document is permitted only with the express written permission of GBA, and only for purposes of scholarly research or book review. Only members of GBA may use this document or its wording as a complement to or as an element of a report of any kind. Any other firm, individual, or other entity that so uses this document without being a GBA member could be committing negligent or intentional (fraudulent) misrepresentation.



February 1, 2022  
ES-8009.01

## Earth Solutions NW LLC

Geotechnical Engineering, Construction  
Observation/Testing and Environmental Services

Design Built Homes, LLC  
11400 Southeast 8<sup>th</sup> Street, Suite 415  
Bellevue, Washington 98004

Attention: Mr. Todd Sherman

Dear Mr. Sherman:

Earth Solutions NW, LLC (ESNW) is pleased to present this report titled "Geotechnical Engineering Study, Lorenzini Short Plat, 4719 – 86<sup>th</sup> Avenue Southeast and 84XX Southeast 47<sup>th</sup> Street, Mercer Island, Washington".

The native soil underlying the site consists of glacial till based on our observation of the subsurface conditions. In our opinion, the proposed residence can be supported on conventional continuous and spread footing foundations bearing on competent native soils, competent existing fill, or new structural fill. We anticipate suitable bearing soils will be encountered at depths of approximately two feet below existing grades. Where loose or unsuitable soil conditions are exposed at foundation subgrade elevations, compaction of the soils to the specifications of structural fill, or overexcavation and replacement with a suitable structural fill material will be necessary.

Groundwater seepage was not observed during our fieldwork (December 22, 2021). However, the client should anticipate groundwater seepage on the site at the contact with the unweathered glacial till. The maximum depth-of-exploration was seven and one-half feet below the existing surface elevations.

We performed infiltration testing at the request of the design team. We observed no infiltration during the testing procedure. We recommend full infiltration not be pursued on the subject site as a result. Limited infiltration measures can be considered, such as permeable pavement. Where permeable pavement is to be utilized, an overflow capacity should be designed into the system.

Recommendations for foundation design, site preparation, drainage, and other pertinent recommendations are provided in this study. We appreciate the opportunity to be of service to you on this project. If you have questions regarding the content of this geotechnical engineering study, please call.

Sincerely,

**EARTH SOLUTIONS NW, LLC**

Stephen H. Avril  
Project Manager

## Table of Contents

ES-8009.01

	<u>PAGE</u>
<b><u>INTRODUCTION</u></b> .....	1
<u>General</u> .....	1
<u>Project Description</u> .....	1
<b><u>SITE CONDITIONS</u></b> .....	2
<u>Surface</u> .....	2
<u>Subsurface</u> .....	2
Topsoil .....	2
Fill .....	2
Native Soil .....	3
Geologic Setting .....	3
Groundwater .....	3
<b><u>ENVIRONMENTALLY CRITICAL AREA ASSESSMENT</u></b> .....	3
<b><u>DISCUSSION AND RECOMMENDATIONS</u></b> .....	4
<u>General</u> .....	4
<u>Site Preparation and Earthwork</u> .....	4
In-situ Soils .....	6
Imported Soils .....	6
Structural Fill .....	6
<u>Foundations</u> .....	6
<u>Seismic Design Considerations</u> .....	7
<u>Slab-On-Grade Floors</u> .....	8
<u>Retaining Walls</u> .....	8
<u>Drainage</u> .....	9
<u>Infiltration Evaluation</u> .....	9
<u>Excavations and Slopes</u> .....	9
<u>Utility Support and Trench Backfill</u> .....	10
<b><u>LIMITATIONS</u></b> .....	10
<u>Additional Services</u> .....	10

## **Table of Contents**

**Cont'd**

**ES-8009.01**

### **GRAPHICS**

<b>Plate 1</b>	<b>Vicinity Map</b>
<b>Plate 2</b>	<b>Test Pit Location Plan</b>
<b>Plate 3</b>	<b>Retaining Wall Drainage Detail</b>
<b>Plate 4</b>	<b>Footing Drain Detail</b>

### **APPENDICES**

<b>Appendix A</b>	<b>Subsurface Exploration Test Pit Logs</b>
<b>Appendix B</b>	<b>Laboratory Test Results</b>

**GEOTECHNICAL ENGINEERING STUDY  
LORENZINI SHORT PLAT  
4719 – 86<sup>TH</sup> AVENUE SOUTHEAST AND  
84XX SOUTHEAST 47<sup>TH</sup> STREET  
MERCER ISLAND, WASHINGTON**

**ES-8009.01**

**INTRODUCTION**

**General**

The subject site is located on the west side of 86<sup>th</sup> Avenue Southeast, south of the intersection with Southeast 47<sup>th</sup> Street in Mercer Island, Washington. The site is currently developed with a single-family residential structure, driveway, and general landscape areas. Site development plans include the construction of three single-family residences and associated improvements following demolition of the existing structure.

The purpose of this study was to explore subsurface conditions across the site and develop geotechnical recommendations for the proposed development. Our scope of services for completing this geotechnical engineering study included the following:

- Site exploration consisting of test pits advanced within four locations on the property;
- Laboratory testing of soil samples obtained during subsurface exploration;
- Engineering analyses of data gathered during site exploration, and;
- Preparation of this report.

The following documents/maps were reviewed as part of our report preparation:

- Geologic Map of Washington, Northwest Quadrant, Dragovich, Logan, et al, 2002, and;
- Washington USDA Soil Conservation Survey (SCS).

**Project Description**

Final site design was not complete at the time of report production; however, we understand the properties will be redeveloped with three new single-family residences and associated improvements.

Given the topographic change of about 25 feet across the site, grading activities will likely involve cuts and fills up to about ten feet to establish the final design grades.



Building construction is anticipated to consist of relatively lightly loaded wood framing and slab-on-grade floors. Perimeter foundation loading is expected to range from approximately one to two kips per foot. Slab-on-grade loading is expected to be on the order of 150 pounds per square foot (psf).

If the above design assumptions are incorrect or change, ESNW should be contacted to review the recommendations in this report. ESNW should review the final design to confirm that the geotechnical recommendations included in this report have been incorporated into the project plans.

## **SITE CONDITIONS**

### **Surface**

The subject site is located on the west side of 86<sup>th</sup> Avenue Southeast, south of the intersection with Southeast 47<sup>th</sup> Street in Mercer Island, Washington. The site is comprised of a single tax parcel, and was occupied by a single-family residence at the time of report production.

The existing site topography is sloped in nature, descending from east to west, with topographic relief on the order of 25 feet across the entirety of the site. Taken overall, slope inclinations across the entirety of the site are on the order of 10 percent, with the steepest section in the western portion of the site inclined at approximately 14 percent.

### **Subsurface**

ESNW representatives observed, logged and sampled four test pits, associated with this report. The test pits were advanced using an excavator and operator contracted by the client. The approximate location of the test pits is depicted on the Test Pit Location Plan (Plate 2). Please refer to the soil logs provided in Appendix A for a more detailed description of the subsurface conditions. Test pit TP-4 was terminated at a shallow depth due to the presence of an irrigation pipe within the test pit.

### **Topsoil**

Topsoil was encountered at the test locations on the order off six to 14 inches in thickness. Where topsoil is encountered during site grading activities, it is not suitable for use as structural fill nor should it be mixed with material to be used as structural fill. Topsoil or otherwise unsuitable material can be used in landscaping areas if desired.

### **Fill**

Fill soil was not encountered at the test locations during our fieldwork. Fill soil may likely be encountered surrounding the existing buildings, roads, and utility alignments, and will have to be evaluated during construction for use as structural fill.

## **Native Soil**

Underlying the topsoil at the test locations, native soils consisting of silty sand (Unified Soil Classification, SM) were encountered. The native soils were generally observed in a medium dense grading to very dense condition. These soil types were observed extending to the maximum exploration depth of seven and one-half feet below existing grades.

## **Geologic Setting**

The referenced geologic map resource identifies glacial till (Qvt) deposits. The referenced SCS soil survey describes Alderwood gravelly sandy loam (AgC) 8 to 15 percent slope series soils for the majority of the site; and Kitsap silt loam (KpB) 2 to 8 percent slope series soils for the western portion of the site. Alderwood series of soil is typified by loamy glacial drift over glaciomarine deposits. Whereas Kitsap series soils are typically comprised of lacustrine depositional environments. The majority of the native soil observed at the test locations are consistent with glacial till which is a component of glacial drift.

## **Groundwater**

Groundwater seepage was not observed during the fieldwork (December 2021). Seepage can be present on sites underlain by glacial till and will typically be in a perched condition atop the unweathered till. Seepage should be expected within excavations at this site; particularly during the winter, spring, and early summer months. Groundwater seepage rates and elevations fluctuate depending on many factors, including precipitation duration and intensity, the time of year, and soil conditions. In general, groundwater flow rates are higher during the wetter, winter months. However, the groundwater table was not observed on the subject site.

## **ENVIRONMENTALLY CRITICAL AREA ASSESSMENT**

As part of our report preparation, we assessed the site for potential critical areas utilizing the Mercer Island online GIS resources (critical areas maps). The subject site is not described as possessing geologic hazard areas with the exception of a historic scarp and a seismic hazard delineated for portions of the site.

The existing site topography is sloped in nature, descending from east to west, with topographic relief on the order of 25 feet across the entirety of the site. Taken overall, slope inclinations across the entirety of the site are on the order of 10 percent, with the steepest section in the western portion of the site inclined at approximately 14 percent.

The historic scarp is located on the subject site according to our review of the online GIS website provided by the City of Mercer Island. The scarp is shown bisecting the current residence, and is semi-circle in shape with the limits of the scarp described for the west side of the current residence and on the southern neighboring property. We observed no surficial signs that the scarp was active during our visual site reconnaissance.

With respect to the seismic hazard, liquefaction is a phenomenon where saturated or loose soil suddenly loses internal strength and behaves as a fluid. This behavior is in response to increased pore water pressures resulting from an earthquake or another intense ground shaking. In our opinion, site susceptibility to liquefaction may be considered negligible. The absence of a shallow groundwater table and the relative density of the native glacial till soil are the primary bases for this opinion.

## **DISCUSSION AND RECOMMENDATIONS**

### **General**

In our opinion, construction of the proposed structure is feasible from a geotechnical standpoint. The proposed buildings can be supported on conventional continuous and spread footing foundations bearing on competent native soils, competent existing fill, or new structural fill. Native soil capable of supporting residential foundations will be encountered at a depth of approximately two feet below existing grade in most areas. Slab-on-grade floors should be supported on competent native soil or structural fill. Where loose or unsuitable soil conditions are exposed at foundation subgrade elevations, compaction of the soils to the specifications of structural fill, or overexcavation and replacement with a suitable structural fill material will be necessary. Recommendations for foundation design, site preparation, drainage, and other pertinent geotechnical recommendations are provided in the following sections of this study.

This study has been prepared for the exclusive use of Design Built Homes, LLC and their representatives. No warranty, expressed or implied, is made. This study has been prepared in a manner consistent with the level of care and skill ordinarily exercised by other members of the profession currently practicing under similar conditions in this area.

### **Site Preparation and Earthwork**

Site preparation activities will involve demolition of the existing structures, site clearing and stripping, and implementation of temporary erosion control measures. The primary geotechnical considerations associated with site preparation activities include erosion control installation, building pad subgrade preparation, retaining wall construction, underground utility installations, and preparation of pavement subgrade areas.

Temporary construction entrances and drive lanes, consisting of at least six inches of quarry spalls (potentially placed over geotextile) can be considered in order to minimize off-site soil tracking and to provide a stable access entrance surface. Erosion control measures should consist of silt fencing placed along the down gradient side of the site. Soil stockpiles should be covered or otherwise protected to reduce soil erosion. Temporary sedimentation ponds or other approaches for controlling surface water runoff should be in place prior to beginning earthwork activities.

Where encountered, topsoil and organic-rich soil is not suitable for foundation support, nor is it suitable for use as structural fill. Topsoil or organic-rich soil can be used in non-structural areas if desired. Over-stripping of the site, however, should be avoided. A representative of ESNW should observe the initial stripping operations, to provide recommendations for stripping depths based on the soil conditions exposed during stripping.

Structural fill soils placed throughout foundation, slab, and pavement areas should be placed over a firm base. Loose or otherwise unsuitable areas of native soil exposed at subgrade elevations should be compacted to structural fill requirements or overexcavated and replaced with a suitable structural fill material. Where structural fill soils are used to construct foundation subgrade areas, the soil should be compacted to the requirements of structural fill described in the following section. Foundation subgrade areas should be protected from disturbance, construction traffic, and excessive moisture. Where instability develops below structural fill areas, use of a woven geotextile below the structural fill areas may be required. A representative of ESNW should observe structural fill placement in foundation, slab, and pavement areas.

The process of removing existing structures may produce voids where foundations and basements were present. Complete restoration of voids caused by the removal of existing structure must be executed as part of overall subgrade and building pad preparation activities, unless the excavation for the new building will be lower than existing basements (where present). The following guidelines for preparing building subgrade areas should be incorporated into the final design:

- Removal of the existing stem walls to an elevation where a four-foot vertical separation between the bottom of new foundations is maintained, and demolition of the slab present in the existing basement, or;
- Complete removal of all foundation elements, stem walls, footing drains, sewer and storm drainage pipes, etc. within the footprint of the existing structure.
- Where voids and related demolition disturbances extend below planned subgrade elevations, restoration of these areas should be completed. Structural fill should be used to restore voids or unstable areas resulting from the removal of existing structural improvements.
- Where pipes for stormwater and sanitary sewer are encountered, they should be plugged and abandoned.
- Recompact, or overexcavate and replace, areas of existing fill, if present, exposed at building subgrade elevations. ESNW should confirm subgrade conditions and the required level of recompaction, or overexcavation and replacement, during site preparation activities. Overexcavations should extend into competent native soils, and structural fill should be used to restore subgrades areas.
- ESNW should confirm the overall suitability of prepared subgrade areas following site preparation activities.

## **In-situ Soils**

The soils encountered at the test sites have a moderate sensitivity to moisture and were generally in a moist condition at the time of the exploration (December 2021). In this respect, the in-situ soils may not be suitable for use as structural fill if the soil moisture content is more than about 3 percent above the optimum level at the time of construction. In general, soils encountered during the site excavations that are excessively over the optimum moisture content will require moisture conditioning prior to placement and compaction. Conversely, soils that are below the optimum moisture content will require moisture conditioning through the addition of water prior to use as structural fill. If the in-situ soils are determined to not be suitable for use as structural fill, then use of a suitable imported soil may be necessary. In our opinion, a contingency should be included in the project budget for exporting unsuitable soil and importing structural fill; or moisture conditioning recommendations can be provided upon request based on field observations during the construction phase of on-site work.

## **Imported Soils**

Imported soil intended for use as structural fill should consist of a well graded granular soil with a moisture content that is at or near the optimum level. During wet weather conditions, imported soil intended for use as structural fill should consist of a well graded granular soil with a fines content of 5 percent or less defined as the percent passing the #200 sieve, based on the minus three-quarter inch fraction.

## **Structural Fill**

Structural fill is defined as compacted soil placed in foundation, slab-on-grade, and roadway areas. Fills placed to construct permanent slopes and throughout retaining wall and utility trench backfill areas are also considered structural fill. Soils placed in structural areas should be placed in loose lifts of 12 inches or less and compacted to a relative compaction of 95 percent, based on the laboratory maximum dry density as determined by the Modified Proctor Method (ASTM D-1557). Additionally, more stringent compaction specifications may be required for utility trench backfill zones, depending on the responsible utility district or jurisdiction.

## **Foundations**

Based on the results of our study, the proposed residential structures can be supported on conventional spread and continuous footings bearing on competent native soils, competent existing fill or new structural fill. Based on the soil conditions encountered at the test sites, competent native soils suitable for support of foundations should be encountered at depths of approximately two feet below existing grades. Where loose or unsuitable soil conditions are exposed at foundation subgrade elevations, compaction of the soils to the specifications of structural fill, or overexcavation and replacement with structural fill, may be necessary.

Provided foundations will be supported as described above, the following parameters can be used for design of new foundations:

- Allowable soil bearing capacity 2,500 psf
- Passive earth pressure 300 pcf (equivalent fluid)
- Coefficient of friction 0.40

A one-third increase in the allowable soil bearing capacity can be assumed for short-term wind and seismic loading conditions. The above passive pressure and friction values include a factor-of-safety of 1.5. With structural loading as expected, total settlement in the range of one inch and differential settlement of about one-half inch is anticipated. The majority of the settlements should occur during construction, as dead loads are applied.

**Seismic Design Considerations**

The 2018 International Building Code (2018 IBC) recognizes the most recent edition of the Minimum Design Loads for Buildings and Other Structures manual (ASCE 7-16) for seismic design, specifically with respect to earthquake loads. Based on the soil conditions encountered at the test pit locations, the parameters and values provided below are recommended for seismic design per the 2018 IBC.

Parameter	Value
Site Class	D*
Mapped short period spectral response acceleration, $S_s (g)$	1.438
Mapped 1-second period spectral response acceleration, $S_1 (g)$	0.499
Short period site coefficient, $F_a$	1.000
Long period site coefficient, $F_v$	1.800
Adjusted short period spectral response acceleration, $S_{MS} (g)$	1.438
Adjusted 1-second period spectral response acceleration, $S_{M1} (g)$	0.898
Design short period spectral response acceleration, $S_{Ds} (g)$	0.959
Design 1-second period spectral response acceleration, $S_{D1} (g)$	0.599

\* Assumes very dense soil conditions, encountered to a maximum depth of 7.5 feet bgs during the December 2021 field exploration, remain very dense to at least 100 feet bgs. Based on our experience with the project geologic setting (glacial till) across the Puget Sound region, soil conditions are likely consistent with this assumption.

Further discussion between the project structural engineer, the project owner (or their representative), and ESNW may be prudent to determine the possible impacts to the structural design due to increased earthquake load requirements under the 2018 IBC. ESNW can provide additional consulting services to aid with design efforts, including supplementary geotechnical and geophysical investigation, upon request.

Liquefaction is a phenomenon where saturated or loose soil suddenly loses internal strength and behaves as a fluid. This behavior is in response to increased pore water pressures resulting from an earthquake or another intense ground shaking. In our opinion, site susceptibility to liquefaction may be considered negligible. The absence of a shallow groundwater table and the dense characteristics of the native soil were the primary bases for this opinion.

### **Slab-On-Grade Floors**

Slab-on-grade floors for the proposed buildings constructed at this site should be supported on a firm and unyielding subgrade. Where feasible, the soil exposed at the slab-on-grade subgrade level can be compacted in place to the specifications of structural fill. Unstable or yielding areas of the subgrade should be recompacted or overexcavated and replaced with suitable structural fill prior to construction of the slab. A capillary break consisting of a minimum of four inches of free draining crushed rock or gravel should be placed below the slab. The free draining material should have a fines content of 5 percent or less (percent passing the #200 sieve, based on the minus three-quarter inch fraction). In areas where slab moisture is undesirable, installation of a vapor barrier below the slab should be considered. If a vapor barrier is to be utilized it should be a material specifically designed for use as a vapor barrier and should be installed in accordance with the manufacturer's specifications.

### **Retaining Walls**

Retaining walls must be designed to resist earth pressures and applicable surcharge loads. The following parameters can be used for retaining wall design:

- Active earth pressure (yielding condition) 35 pcf (equivalent fluid)
- At-rest earth pressure (restrained condition) 55 pcf
- Traffic surcharge for passenger vehicles (where applicable) 70 psf (rectangular distribution)
- Passive earth pressure 300 pcf (equivalent fluid)
- Coefficient of friction 0.40
- Seismic surcharge (active condition) 8H (where H equals retained height)

Additional surcharge loading from adjacent foundations, sloped backfill, or other loads should be included in the retaining wall design. Drainage should be provided behind retaining walls such that hydrostatic pressures do not develop. If drainage is not provided, hydrostatic pressures should be included in the wall design.

Retaining walls should be backfilled with free draining material that extends along the height of the wall, and a distance of at least 18 inches behind the wall. The upper one foot of the wall backfill can consist of a less permeable soil, if desired. A perforated drain pipe should be placed along the base of the wall and connected to an approved discharge location. A typical retaining wall drainage detail is provided on Plate 3.

## **Drainage**

Seepage will likely be encountered in excavations on the site, particularly during winter, spring, and early summer months. Temporary measures to control surface water runoff and groundwater during construction would likely involve interceptor trenches and sumps. ESNW should be consulted during preliminary grading to identify areas of seepage and to provide recommendations to reduce the potential for instability related to seepage effects.

Finish grades must slope away from the building at an inclination of at least 2 percent for a distance of at ten feet or as adjacent building setbacks allow. In addition, surface water should be controlled utilizing best management practices (BMP) during, and after, construction on the subject site.

Footing drains should be installed given the nature of the soils on the site. A typical foundation drain detail for footings not placed directly against shoring is provided as Plate 4.

## **Infiltration Evaluation**

The subject site is underlain by glacial till deposits within the proposed infiltration location, based on our observation of the subsurface conditions. The soil underlying the site consists of dense to very dense glacial till. These soils typically have very low or negligible infiltration capacity.

A Pilot Infiltration Test (PIT) was performed in test pit TP-2 at a depth of four feet below existing grades. No infiltration was observed during the test procedure.

Based on our experience targeted infiltration such as permeable pavement may be feasible on the subject site given a one-foot vertical separation is maintained from the cemented glacial till material present on the site. Additionally, where limited infiltration is employed, overflow should be considered such as underdrains in permeable pavement areas.

## **Excavations and Slopes**

The Federal Occupation Safety and Health Administration (OSHA) and the Washington Industrial Safety and Health Act (WISHA) provide soil classification in terms of temporary slope inclinations. Based on the soil conditions encountered at the test locations, existing fill, loose native soil and any soil where groundwater seepage is exposed, are classified as Type C by OSHA/WISHA. Temporary slopes over four feet in height in Type C soils must be sloped no steeper than 1.5H:1V (Horizontal:Vertical). The presence of perched groundwater may cause caving of the temporary slopes due to hydrostatic pressure. The native silty sand glacial till soils observed are classified as Type A. Temporary slopes over four feet in height in Type A soils must be sloped no steeper than 0.75H:1V. Temporary excavations with inclinations steeper than those described may be acceptable from a geotechnical standpoint. ESNW should be consulted during the design phase to provide recommendations for steeper temporary excavations if necessary. ESNW should observe site excavations to confirm the soil type and allowable slope inclination. If the recommended temporary slope inclination cannot be achieved, temporary shoring may be necessary to support excavations. Additionally, due to the presence of slopes on the subject site, slope surcharging should be taken into consideration when planning open cuts.



Permanent slopes should maintain a gradient of 2H:1V, or flatter, and should be planted with vegetation to enhance stability and to minimize erosion. A representative of ESNW should observe temporary and permanent slopes to confirm the slope inclinations, and to provide additional excavation and slope recommendations, as necessary.

### **Utility Support and Trench Backfill**

In our opinion, the soils anticipated to be exposed in utility excavations should generally be suitable for support of utilities. Organic or highly compressible soils encountered in the trench excavations should not be used for supporting utilities. The on-site soil may not be suitable for use as trench backfill if the soil moisture content is too high at the time of compaction. Utility trench backfill should be placed and compacted to the specifications of structural fill provided in this report, or to the applicable City of Mercer Island specifications. Seepage should be anticipated within utility trench excavations.

### **LIMITATIONS**

The recommendations and conclusions provided in this geotechnical engineering study are professional opinions consistent with the level of care and skill that is typical of other members in the profession currently practicing under similar conditions in this area. A warranty is not expressed or implied. Variations in the soil and groundwater conditions observed at the test locations may exist and may not become evident until construction. ESNW should reevaluate the conclusions in this geotechnical engineering study if variations are encountered.

### **Additional Services**

ESNW should have an opportunity to review the final design with respect to the geotechnical recommendations provided in this report. ESNW should also be retained to provide testing and consultation services during construction.



Reference:  
King County, Washington  
OpenStreetMap.org



NOTE: This plate may contain areas of color. ESNW cannot be responsible for any subsequent misinterpretation of the information resulting from black & white reproductions of this plate.



**Earth Solutions NW LLC**

Geotechnical Engineering, Construction  
Observation/Testing and Environmental Services

**Vicinity Map  
Lorenzini Short Plat  
Mercer Island, Washington**

Drwn. CAM	Date 01/12/2022	Proj. No. 8009.01
Checked BCS	Date Jan. 2022	Plate 1

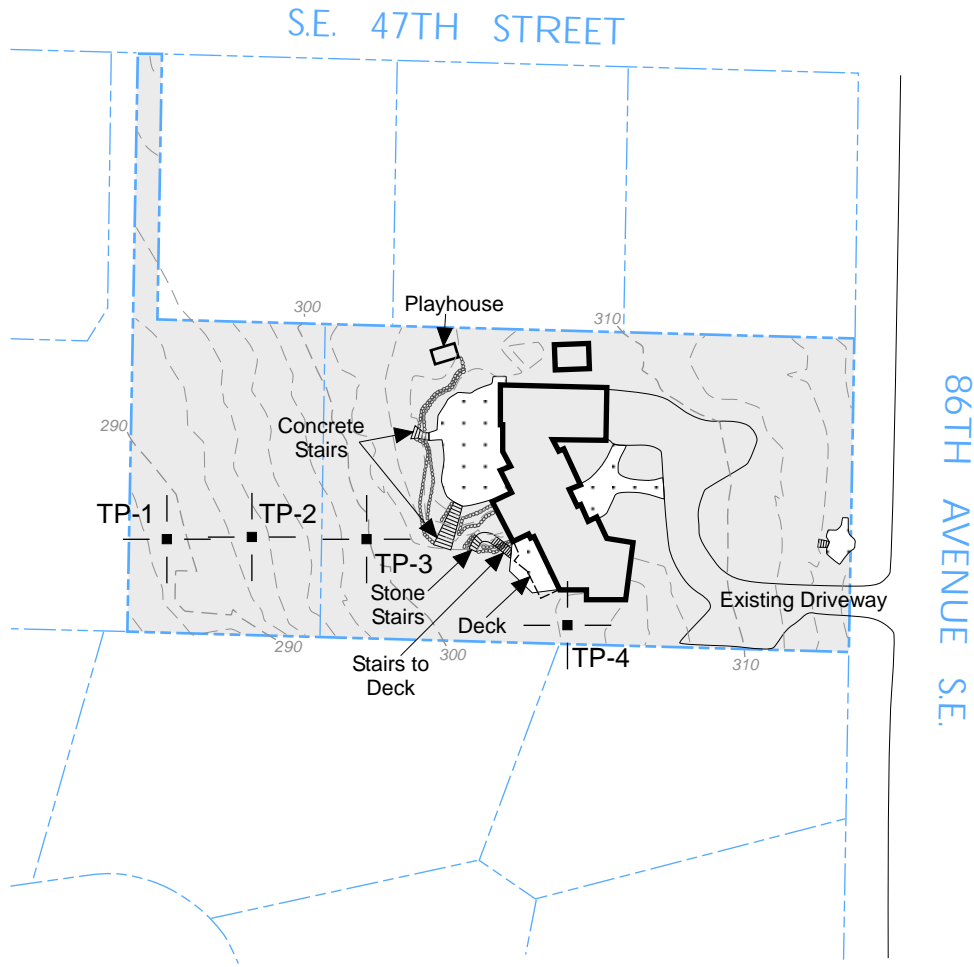

**LEGEND**

TP-1 | — ■ — | Approximate Location of ESNW Test Pit, Proj. No. ES-8009.01, Dec. 2021

 Subject Site

 Existing Building

 Concrete

 Rockery

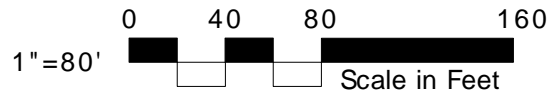

NOTE: The graphics shown on this plate are not intended for design purposes or precise scale measurements, but only to illustrate the approximate test locations relative to the approximate locations of existing and / or proposed site features. The information illustrated is largely based on data provided by the client at the time of our study. ESNW cannot be responsible for subsequent design changes or interpretation of the data by others.

NOTE: This plate may contain areas of color. ESNW cannot be responsible for any subsequent misinterpretation of the information resulting from black & white reproductions of this plate.



**Earth Solutions NW<sub>LLC</sub>**

Geotechnical Engineering, Construction  
Observation/Testing and Environmental Services

**Test Pit Location Plan  
Lorenzini Short Plat  
Mercer Island, Washington**

Drwn. CAM	Date 01/12/2022	Proj. No. 8009.01
Checked BCS	Date Jan. 2022	Plate 2

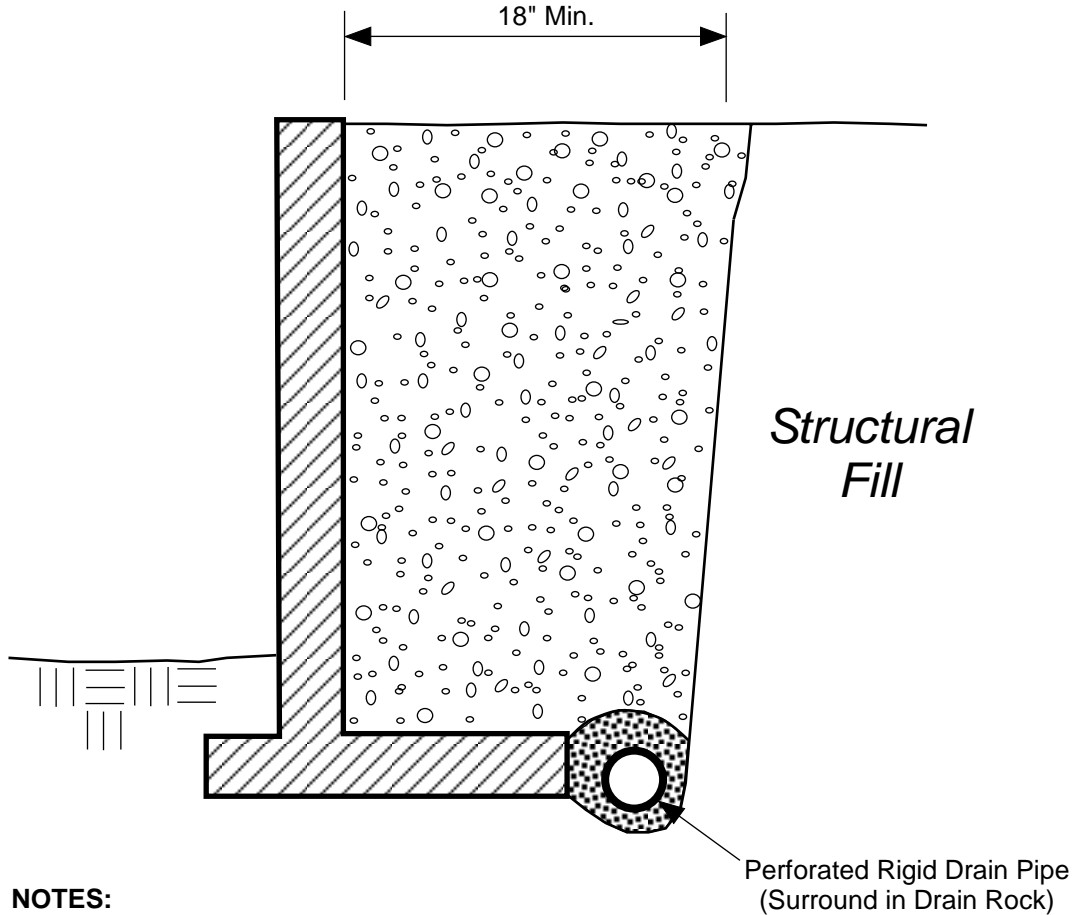

**NOTES:**

- Free-draining Backfill should consist of soil having less than 5 percent fines. Percent passing No. 4 sieve should be 25 to 75 percent.
- Sheet Drain may be feasible in lieu of Free-draining Backfill, per ESNW recommendations.
- Drain Pipe should consist of perforated, rigid PVC Pipe surrounded with 1-inch Drain Rock.

SCHEMATIC ONLY - NOT TO SCALE  
NOT A CONSTRUCTION DRAWING

**LEGEND:**

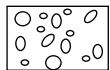

Free-draining Structural Backfill



1-inch Drain Rock

		<b>Earth Solutions NW<sub>LLC</sub></b> Geotechnical Engineering, Construction Observation/Testing and Environmental Services	
<b>Retaining Wall Drainage Detail</b> <b>Lorenzini Short Plat</b> <b>Mercer Island, Washington</b>			
Drwn. CAM	Date 01/12/2022	Proj. No.	8009.01
Checked BCS	Date Jan. 2022	Plate	3

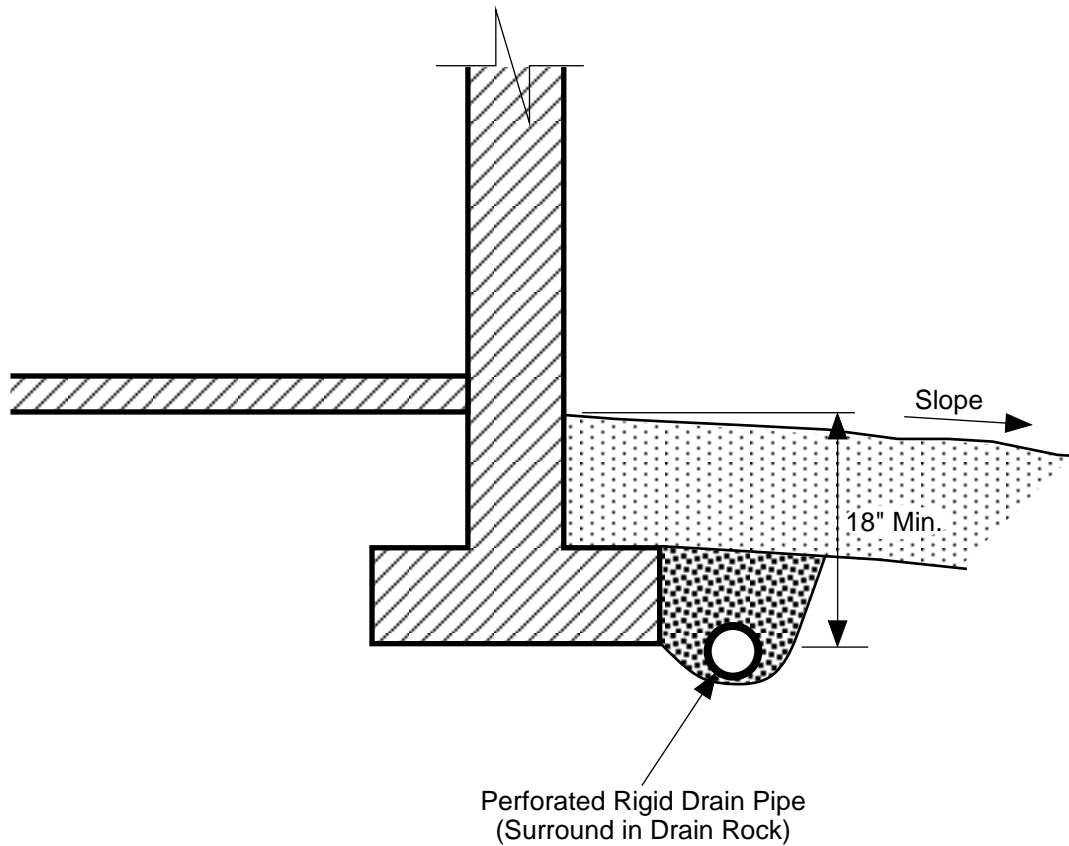

**NOTES:**

- Do NOT tie roof downspouts to Footing Drain.
- Surface Seal to consist of 12" of less permeable, suitable soil. Slope away from building.

SCHEMATIC ONLY - NOT TO SCALE  
NOT A CONSTRUCTION DRAWING

**LEGEND:**

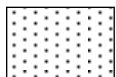
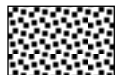
-  Surface Seal: native soil or other low-permeability material.
-  1-inch Drain Rock

	<p><b>Earth Solutions NW<sub>LLC</sub></b></p> <p>Geotechnical Engineering, Construction Observation/Testing and Environmental Services</p>	
<p><b>Footing Drain Detail Lorenzini Short Plat Mercer Island, Washington</b></p>		
Drwn. CAM	Date 01/12/2022	Proj. No. 8009.01
Checked BCS	Date Jan. 2022	Plate 4

## **Appendix A**









### **Subsurface Exploration Test Pit Logs**

#### **ES-8009.01**

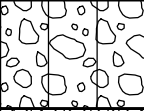
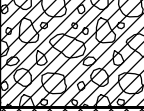
The subsurface conditions at the site were explored by excavating a total of four test pits across accessible portions of the property. The subsurface explorations were completed in December of 2021. The approximate test locations are illustrated on Plate 2 of this report. Logs of the test pits are provided in this Appendix. The test pits were excavated to a maximum depth of seven and one-half feet below existing grades.

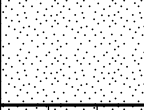
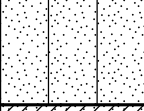
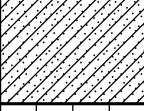
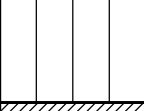
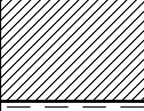
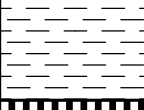
# Earth Solutions NW<sub>LLC</sub>

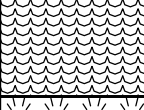
## SOIL CLASSIFICATION CHART

MAJOR DIVISIONS			SYMBOLS		TYPICAL DESCRIPTIONS
			GRAPH	LETTER	
<b>COARSE GRAINED SOILS</b>  MORE THAN 50% OF MATERIAL IS LARGER THAN NO. 200 SIEVE SIZE	<b>GRAVEL AND GRAVELLY SOILS</b>  (LITTLE OR NO FINES)	CLEAN GRAVELS		<b>GW</b>	WELL-GRADED GRAVELS, GRAVEL - SAND MIXTURES, LITTLE OR NO FINES
		(LITTLE OR NO FINES)		<b>GP</b>	POORLY-GRADED GRAVELS, GRAVEL - SAND MIXTURES, LITTLE OR NO FINES
		GRAVELS WITH FINES		<b>GM</b>	SILTY GRAVELS, GRAVEL - SAND - SILT MIXTURES
	MORE THAN 50% OF COARSE FRACTION RETAINED ON NO. 4 SIEVE  (APPRECIABLE AMOUNT OF FINES)	GRAVELS WITH FINES		<b>GC</b>	CLAYEY GRAVELS, GRAVEL - SAND - CLAY MIXTURES
		(APPRECIABLE AMOUNT OF FINES)		<b>SW</b>	WELL-GRADED SANDS, GRAVELLY SANDS, LITTLE OR NO FINES
		CLEAN SANDS		<b>SP</b>	POORLY-GRADED SANDS, GRAVELLY SAND, LITTLE OR NO FINES
	<b>SAND AND SANDY SOILS</b>  (LITTLE OR NO FINES)	CLEAN SANDS		<b>SM</b>	SILTY SANDS, SAND - SILT MIXTURES
		(LITTLE OR NO FINES)		<b>SC</b>	CLAYEY SANDS, SAND - CLAY MIXTURES
		SANDS WITH FINES		<b>ML</b>	INORGANIC SILTS AND VERY FINE SANDS, ROCK FLOUR, SILTY OR CLAYEY FINE SANDS OR CLAYEY SILTS WITH SLIGHT PLASTICITY
MORE THAN 50% OF COARSE FRACTION PASSING ON NO. 4 SIEVE  (APPRECIABLE AMOUNT OF FINES)	SANDS WITH FINES		<b>CL</b>	INORGANIC CLAYS OF LOW TO MEDIUM PLASTICITY, GRAVELLY CLAYS, SANDY CLAYS, SILTY CLAYS, LEAN CLAYS	
	(APPRECIABLE AMOUNT OF FINES)		<b>OL</b>	ORGANIC SILTS AND ORGANIC SILTY CLAYS OF LOW PLASTICITY	
	SILTS AND CLAYS		<b>MH</b>	INORGANIC SILTS, MICACEOUS OR DIATOMACEOUS FINE SAND OR SILTY SOILS	
<b>FINE GRAINED SOILS</b>  MORE THAN 50% OF MATERIAL IS SMALLER THAN NO. 200 SIEVE SIZE	<b>SILTS AND CLAYS</b>  LIQUID LIMIT LESS THAN 50	SANDS WITH FINES		<b>CH</b>	INORGANIC CLAYS OF HIGH PLASTICITY
		(APPRECIABLE AMOUNT OF FINES)		<b>OH</b>	ORGANIC CLAYS OF MEDIUM TO HIGH PLASTICITY, ORGANIC SILTS
		SILTS AND CLAYS		<b>PT</b>	PEAT, HUMUS, SWAMP SOILS WITH HIGH ORGANIC CONTENTS
<b>HIGHLY ORGANIC SOILS</b>				<b>PT</b>	PEAT, HUMUS, SWAMP SOILS WITH HIGH ORGANIC CONTENTS

DUAL SYMBOLS are used to indicate borderline soil classifications.

The discussion in the text of this report is necessary for a proper understanding of the nature of the material presented in the attached logs.



Earth Solutions NW, LLC  
 15365 N.E. 90th Street, Suite 100  
 Redmond, Washington 98052  
 Telephone: 425-449-4704  
 Fax: 425-449-4711

PROJECT NUMBER ES-8009.01 PROJECT NAME Lorenzini Short Plat  
 DATE STARTED 12/22/21 COMPLETED 12/22/21 GROUND ELEVATION 289 ft  
 EXCAVATION CONTRACTOR Client Provided LATITUDE 47.56128 LONGITUDE -122.22549  
 EXCAVATION METHOD \_\_\_\_\_ GROUND WATER LEVEL: \_\_\_\_\_  
 LOGGED BY BCS CHECKED BY SHA  AT TIME OF EXCAVATION \_\_\_\_\_  
 NOTES Depth of Topsoil & Sod 10"-12": lawn grass

DEPTH (ft)	SAMPLE TYPE NUMBER	TESTS	U.S.C.S.	GRAPHIC LOG	MATERIAL DESCRIPTION
0					
			TPSL		Dark brown TOPSOIL 288.0
		MC = 16.6%	SM		Brown silty SAND, medium dense, moist to wet -becomes gray -sparse gravel -moderate iron oxide staining
5		MC = 13.3%			-becomes very dense, weakly cemented
		MC = 16.3% Fines = 35.6%			[USDA Classification: slightly gravelly sandy LOAM] 281.5

Test pit terminated at 7.5 feet below existing grade. No groundwater encountered during excavation. No caving observed.







Earth Solutions NW, LLC  
 15365 N.E. 90th Street, Suite 100  
 Redmond, Washington 98052  
 Telephone: 425-449-4704  
 Fax: 425-449-4711

# TEST PIT NUMBER TP-2

PROJECT NUMBER ES-8009.01 PROJECT NAME Lorenzini Short Plat  
 DATE STARTED 12/22/21 COMPLETED 12/22/21 GROUND ELEVATION 293 ft  
 EXCAVATION CONTRACTOR Client Provided LATITUDE 47.56129 LONGITUDE -122.22542  
 EXCAVATION METHOD \_\_\_\_\_ GROUND WATER LEVEL: \_\_\_\_\_  
 LOGGED BY BCS CHECKED BY SHA  AT TIME OF EXCAVATION \_\_\_\_\_  
 NOTES Depth of Topsoil & Sod ~14": lawn grass

DEPTH (ft)	SAMPLE TYPE NUMBER	TESTS	U.S.C.S.	GRAPHIC LOG	MATERIAL DESCRIPTION
0					
			TPSL		Dark brown TOPSOIL
		MC = 17.6%			
		MC = 14.2% Fines = 35.5%	SM		Brown silty SAND, medium dense to dense, moist to wet  -becomes gray -becomes very dense, light to moderate iron oxide staining, weak cementation  -infiltration test at 4' [USDA Classification: gravelly sandy LOAM]
5		MC = 10.0%			
		MC = 10.9%			
				7.0	286.0



Test pit terminated at 7.0 feet below existing grade. No groundwater encountered during excavation. No caving observed.



Earth Solutions NW, LLC  
 15365 N.E. 90th Street, Suite 100  
 Redmond, Washington 98052  
 Telephone: 425-449-4704  
 Fax: 425-449-4711

# TEST PIT NUMBER TP-3

PROJECT NUMBER ES-8009.01 PROJECT NAME Lorenzini Short Plat  
 DATE STARTED 12/22/21 COMPLETED 12/22/21 GROUND ELEVATION 300 ft  
 EXCAVATION CONTRACTOR Client Provided LATITUDE 47.56127 LONGITUDE -122.22519  
 EXCAVATION METHOD \_\_\_\_\_ GROUND WATER LEVEL: \_\_\_\_\_  
 LOGGED BY BCS CHECKED BY SHA  AT TIME OF EXCAVATION \_\_\_\_\_  
 NOTES Depth of Topsoil & Sod 6"-8": lawn grass

DEPTH (ft)	SAMPLE TYPE NUMBER	TESTS	U.S.C.S.	GRAPHIC LOG	MATERIAL DESCRIPTION
0					
		MC = 16.8% Fines = 33.7%	TPSL		Dark brown TOPSOIL -large 4" diameter tree roots
		MC = 11.7%	SM		Brown silty SAND with gravel, medium dense, moist to wet [USDA Classification: gravelly fine sandy LOAM]  -becomes gray dense
5		MC = 12.7%			-becomes very dense, weakly cemented



Test pit terminated at 6.0 feet below existing grade. No groundwater encountered during excavation. No caving observed.



Earth Solutions NW, LLC  
 15365 N.E. 90th Street, Suite 100  
 Redmond, Washington 98052  
 Telephone: 425-449-4704  
 Fax: 425-449-4711

# TEST PIT NUMBER TP-4

PROJECT NUMBER ES-8009.01 PROJECT NAME Lorenzini Short Plat  
 DATE STARTED 12/22/21 COMPLETED 12/22/21 GROUND ELEVATION 302 ft  
 EXCAVATION CONTRACTOR Client Provided LATITUDE 47.56118 LONGITUDE -122.2249  
 EXCAVATION METHOD \_\_\_\_\_ GROUND WATER LEVEL: \_\_\_\_\_  
 LOGGED BY BCS CHECKED BY SHA  AT TIME OF EXCAVATION \_\_\_\_\_  
 NOTES Depth of Topsoil & Sod 12": lawn grass

DEPTH (ft)	SAMPLE TYPE NUMBER	TESTS	U.S.C.S.	GRAPHIC LOG	MATERIAL DESCRIPTION	
0						
			TPSL		Dark brown TOPSOIL	301.0
		MC = 14.1%	SM		Gray silty SAND, very dense, moist to wet -moderate to heavy iron oxide staining, weakly cemented	300.5

Test pit terminated at 1.5 feet below existing grade. No groundwater encountered during excavation. No caving observed.

**Appendix B**  
**Laboratory Test Results**  
**ES-8009.01**



Earth Solutions NW, LLC  
 15365 N.E. 90th Street, Suite 100  
 Redmond, Washington 98052  
 Telephone: 425-449-4704  
 Fax: 425-449-4711

# GRAIN SIZE DISTRIBUTION

PROJECT NUMBER ES-8009.01

PROJECT NAME Lorenzini Short Plat

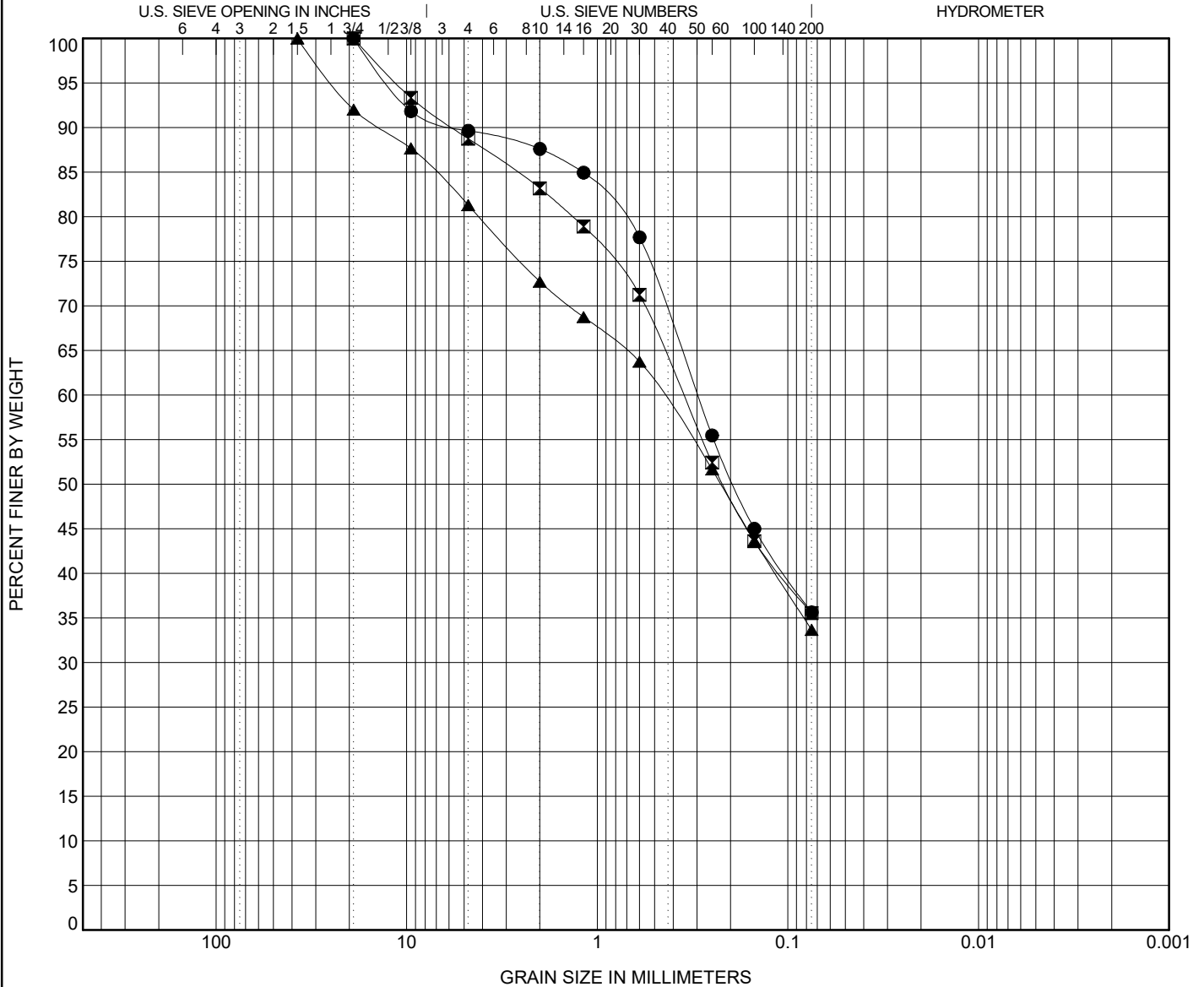

COBBLES	GRAVEL		SAND			SILT OR CLAY
	coarse	fine	coarse	medium	fine	

Specimen Identification			Classification							Cc	Cu
●	TP-01	7.50ft.	<b>USDA: Gray Slightly Gravelly Sandy Loam. USCS: SM.</b>								
☒	TP-02	4.00ft.	<b>USDA: Gray Gravelly Sandy Loam. USCS: SM.</b>								
▲	TP-03	1.00ft.	<b>USDA: Brown Gravelly Fine Sandy Loam. USCS: SM with Gravel.</b>								
Specimen Identification			D100	D60	D30	D10	LL	PL	PI	%Silt	%Clay
●	TP-01	7.5ft.	19	0.299						35.6	
☒	TP-02	4.0ft.	19	0.355						35.5	
▲	TP-03	1.0ft.	37.5	0.457						33.7	

GRAIN SIZE USDA ES-8009.01 LORENZINI SHORT PLAT.GPJ GINT US LAB.GDT 1/6/22

**Report Distribution**

**ES-8009.01**

**EMAIL ONLY**

**Design Built Homes, LLC  
11400 Southeast 8<sup>th</sup> Street, Suite 415  
Bellevue, Washington 98004**

**Attention: Mr. Todd Sherman**